

Titanium Metal Skin™ Label



Functional Specifications

RF air protocol	EPC Class 1 Gen 2; ISO 18000-6C
Operating frequency	902-928 MHz (US), 866-868 MHz (EU)
IC type	Impinj Monza5 ¹
Memory configuration	128 bits EPC, 48 bits serialized TID
Functionality	Read / write (user programmed)
Memory – expected read / write cycles	100,000 cycles at 77°F (25°C)
Data retention	Up to 50 years ²

Performance Characteristics

Read range on metal (2W ERP) ³	Up to 4 ft (1.2 m)
Read range off metal (2W ERP) ³	Up to 2 ft (0.6 m)
Polarization	Linear

Smart Label Specifications

Dimensions / tolerance (mm)	45(+/- 1) x 5.6(+/- 0.6) x 0.86(+/- 0.1)
Dimensions / tolerance (in)	1.77(+/- 0.04) x 0.22(+/- 0.02) x 0.03(+/- 0.004)
Pitch on reel	0.625 in (15.875 mm)
Quantity per reel	1500
Inner reel core diameter	3 in (76.2 mm)
Outer reel diameter	5.1 in (130 mm)
Weight (reel)	2.54 lbs (1.15 kg)



¹ This product utilizes an Impinj Monza5 chip; each tag will have the exact same EPC number and a unique TID number. Xerify will verify the Read/Write function of each chip memory before shipment.

² The chip data retention is based on chip operating under general environment conditions.

³ Actual read range may vary based upon use case and antenna power.

Product Dimensions



Product Reel Dimensions

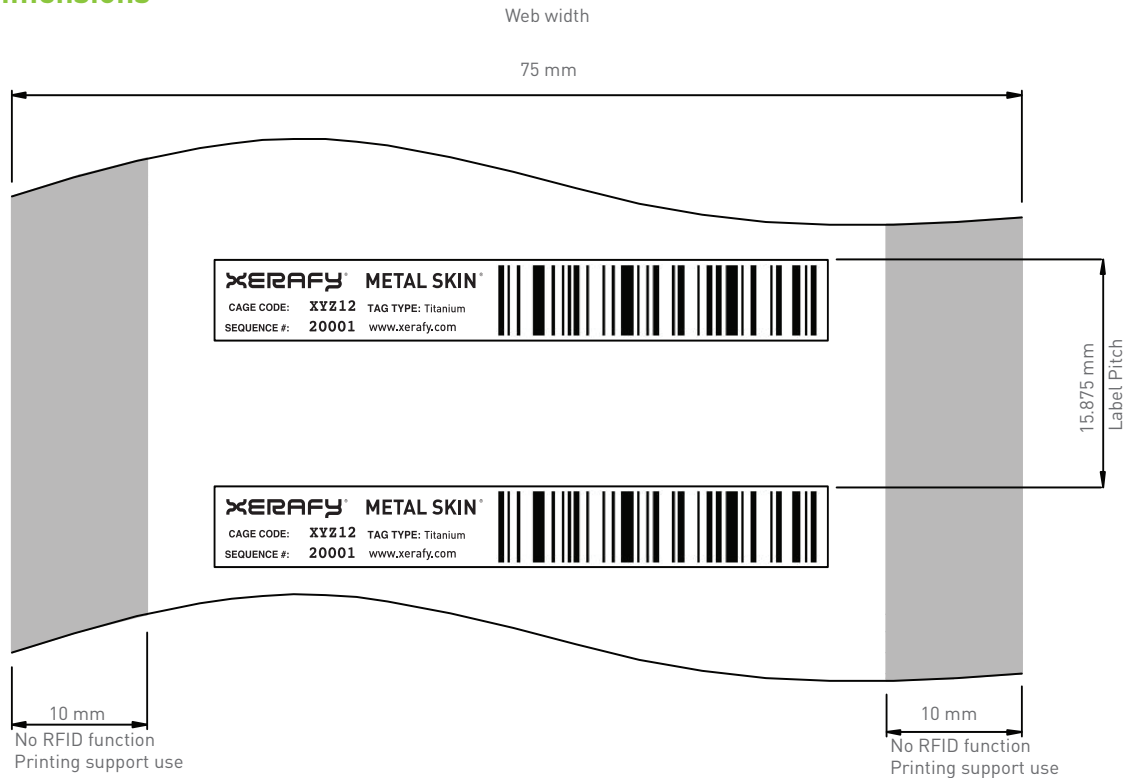

Smart Label Cross Section

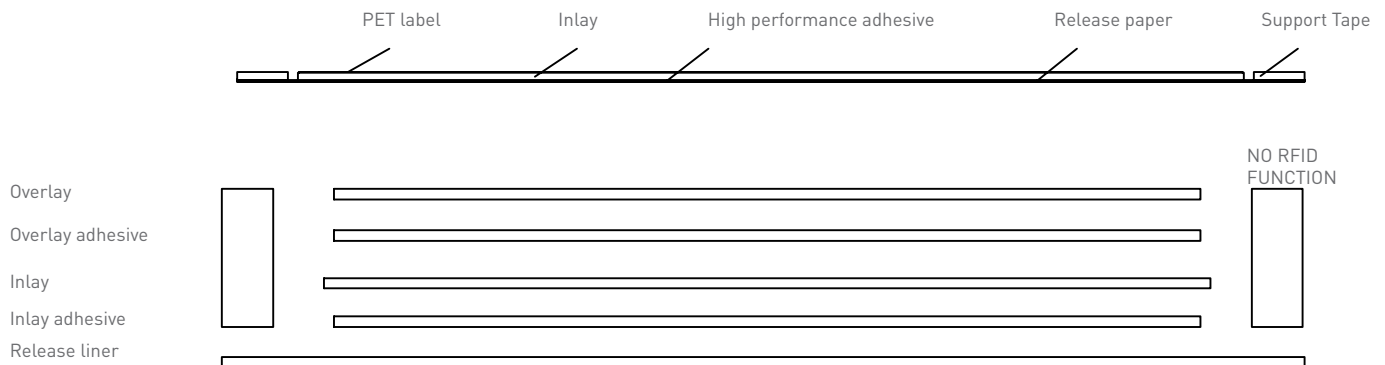

Radiation Pattern

On metal-Horizontal / Vertical

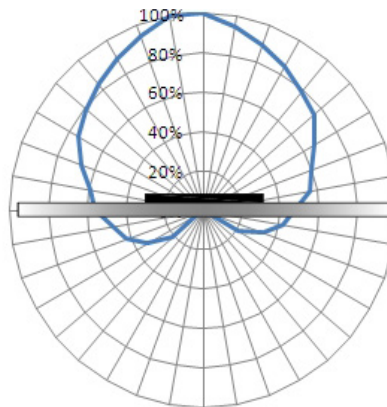
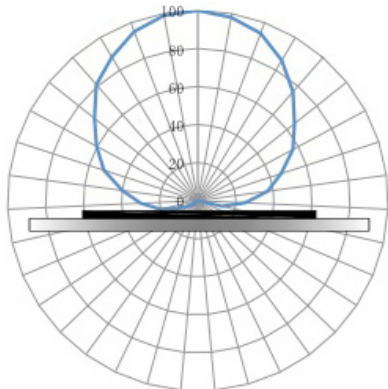

Off metal-Horizontal / Vertical

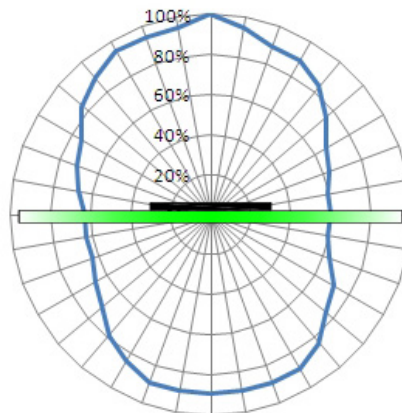
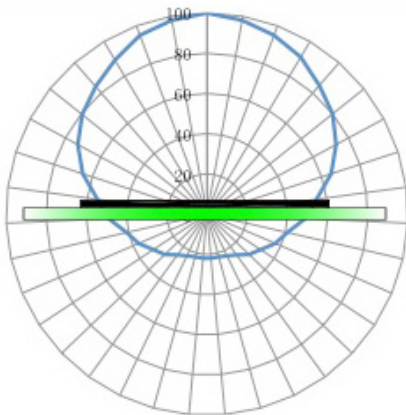

On Liquid-Horizontal / Vertical

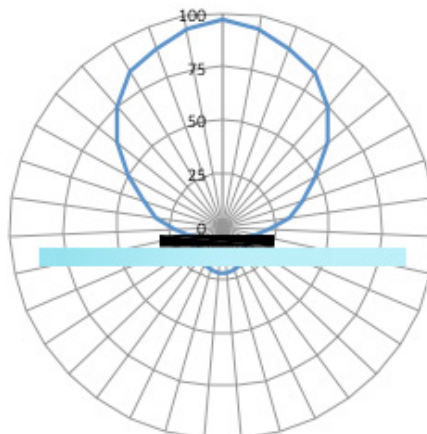
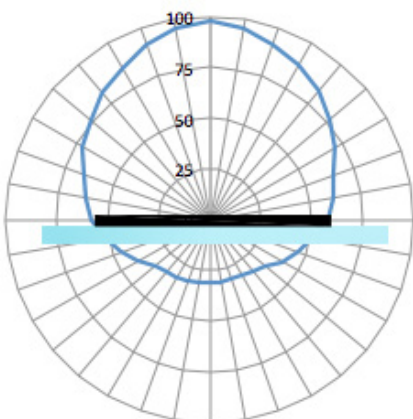

Operational and Environmental Specifications

Operational temperature	
Cold	-40°F (-40°C)
Dry heat	+185°F (+85°C)
Thermal shock	-40°F to 185°F (-40°C to +85°C); cycled
Application temperature	
Cold	-40°F (-40°C)
Dry heat	+185°F (+85°C)
Storage conditions	2 years at +68°F (+20°C) and 50% relative humidity
Shock (drop)	3 ft (1 m) to concrete/granite up to 100 cycles
Vibration	MIL-STD-810F
Compression strength	58 psi (400 kPa)
Compliance	RoHS, CE

Application Instructions

Tag performance when attached on curve surface:

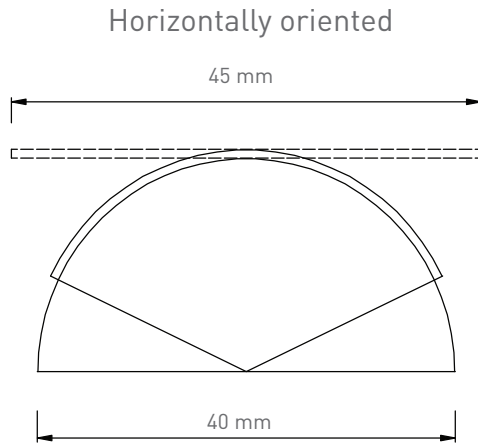

Read range on metal

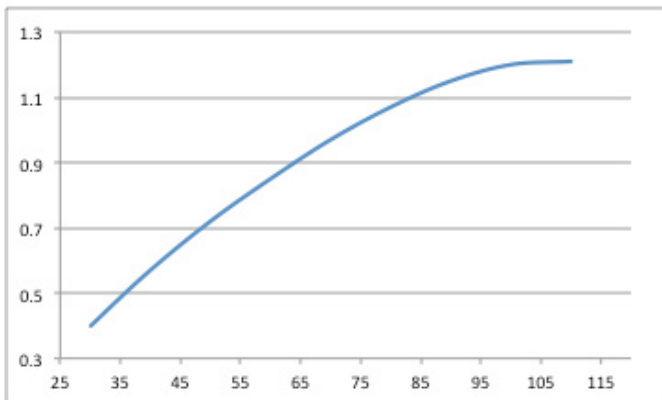

Read range off metal

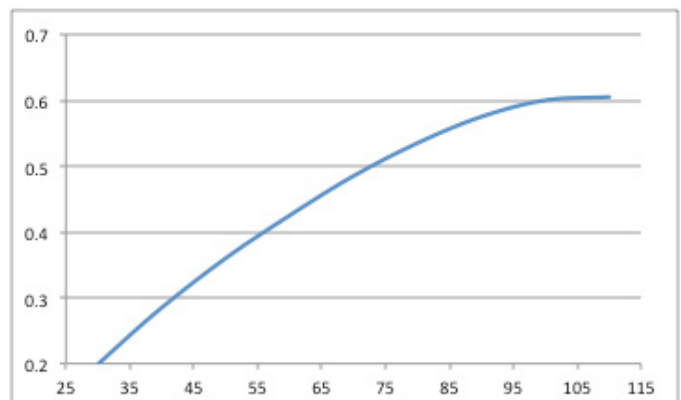

X: Diameter/mm Y: Read Range/ m



Personalization options

Several options are available:

- Pre-encoding - Customer specific encoding of EPC or user memory.
- Customized printing - Customer specific layout including logo, text, numbers, barcodes etc.

Printer Compatibility

Zebra	R110Xi4 (Pitch31.75mm)
-------	------------------------

Order information

X5020-US100-M5	Titanium Metal Skin Label in Roll US
X5020-EU100-M5	Titanium Metal Skin Label in Roll EU